

RITEX

LED SENSOR LIGHT

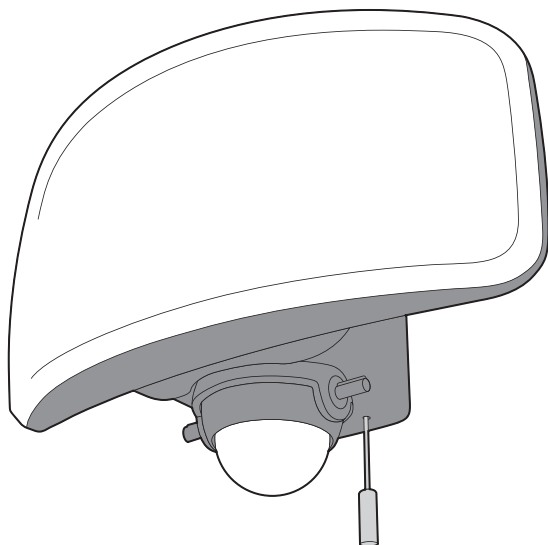

LED-AC1027

27W ワイド フリーアーム式 LED センサーライト

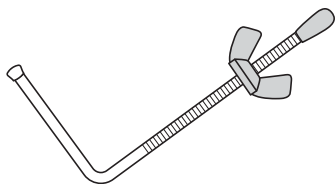

×1

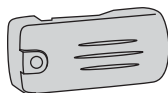

×1

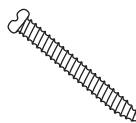

×2

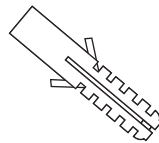

×2

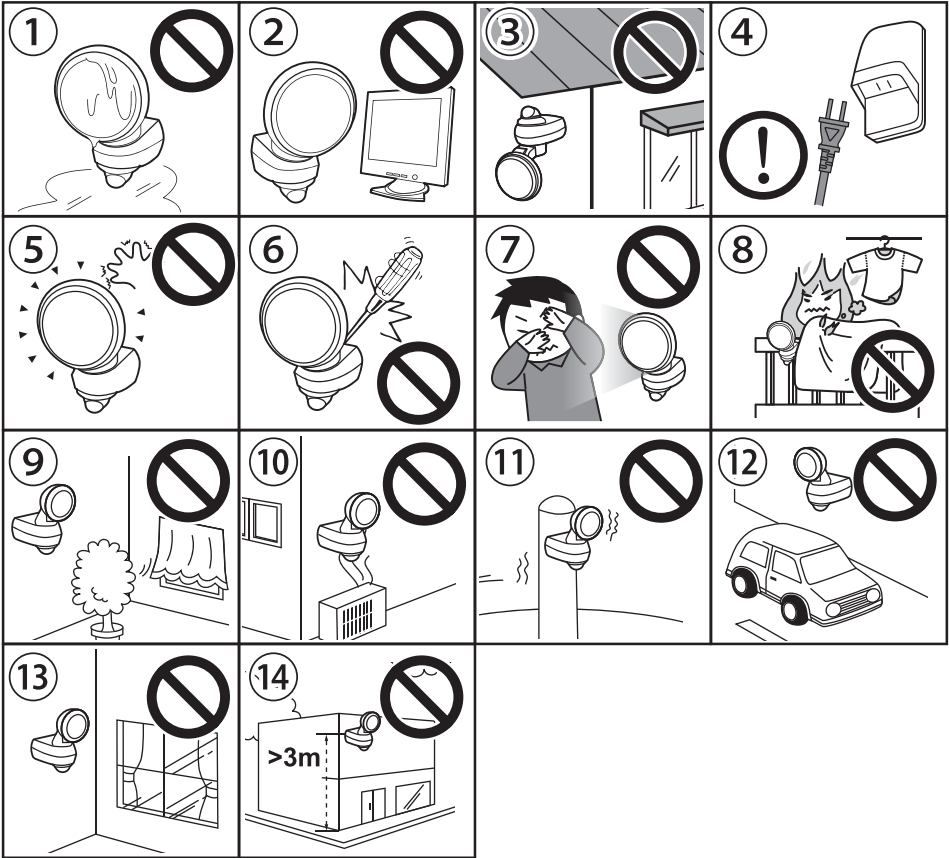

- ①大量の水がかかる場所に設置しない
- ②家電製品や電波を出す機器の近くで使用しない
- ③斜め向き、下向き、逆さまに取り付けけない
- ④屋外へ設置する際は、防雨型コンセントを使用する。電源と直接接続する場合、電源を切れるようスイッチを設置する
- ⑤点灯中および消灯直後、ライト部に触れない
- ⑥分解や改造をしない
- ⑦点灯中は、ライト部を直視しない
- ⑧燃えやすい物の近くに取り付けけない
- ⑨ゆれるものの近くに取り付けけない
- ⑩エアコン等の送風を受ける場所に取り付けけない
- ⑪強い振動を受ける場所に取り付けけない
- ⑫車の通る道路に面した場所に取り付けけない
- ⑬ガラス越しの場所に取り付けけない
- ⑭取り付け高さが3m以上の場所に取り付けけない



Good



Not Good

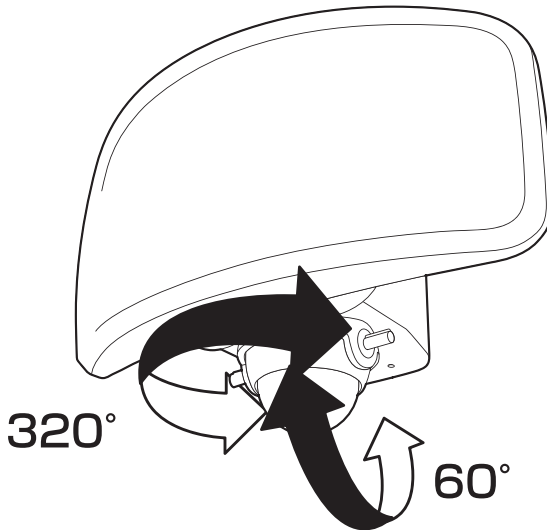
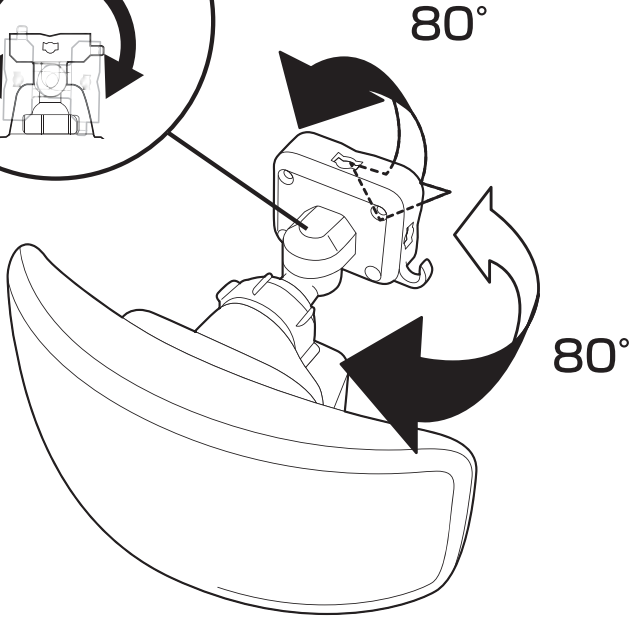
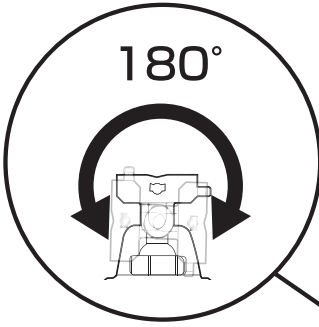

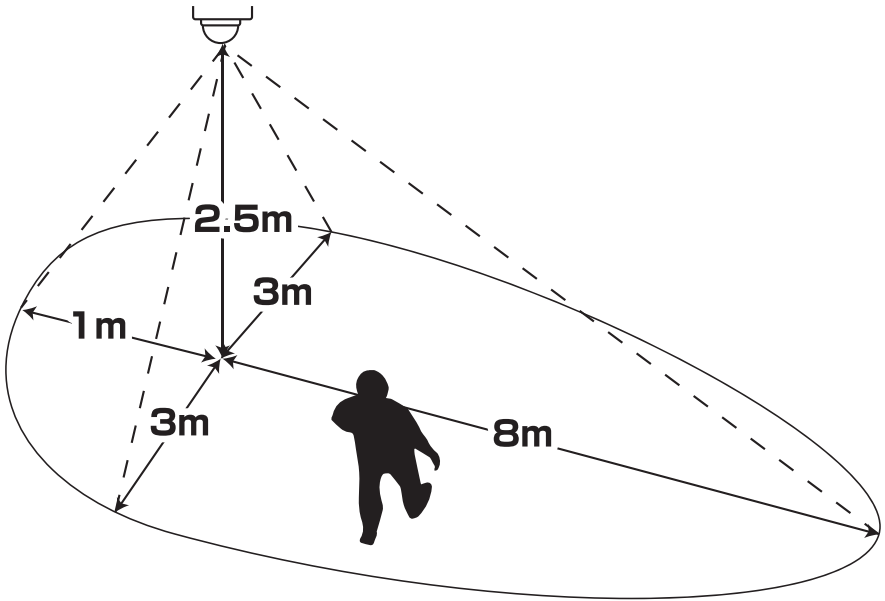

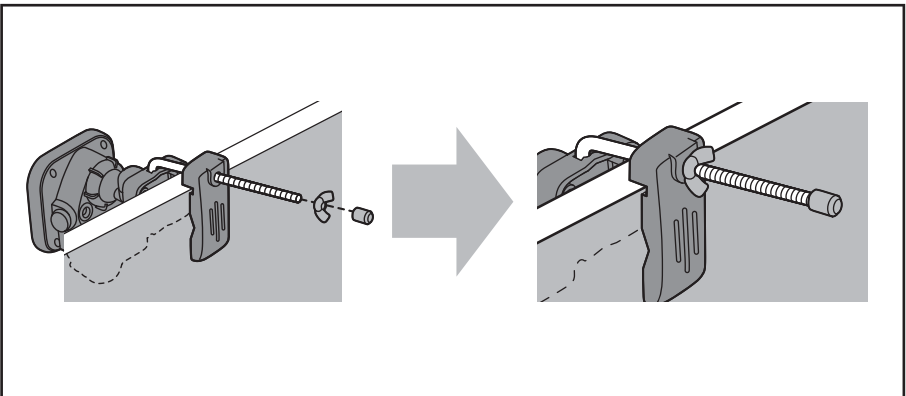
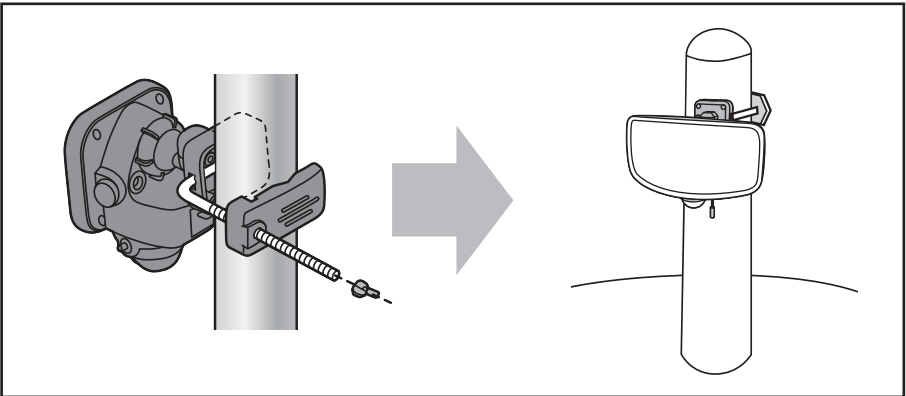
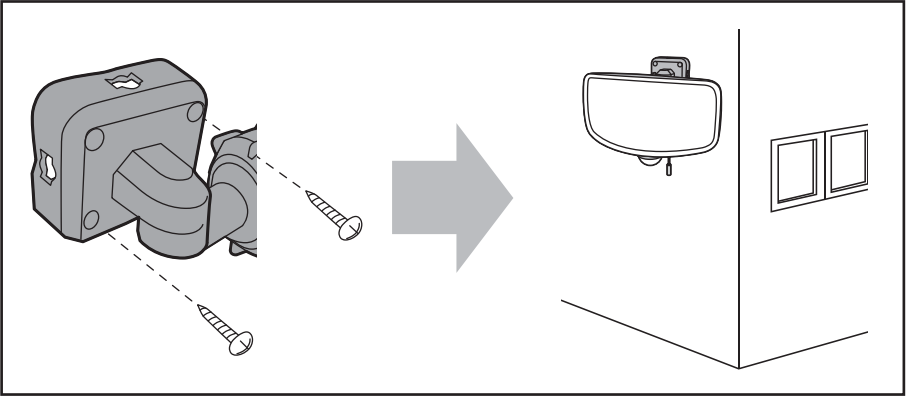



5sec
~
5min

Day time mode

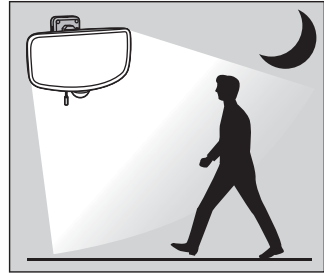
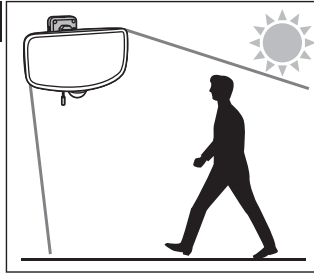

Night mode

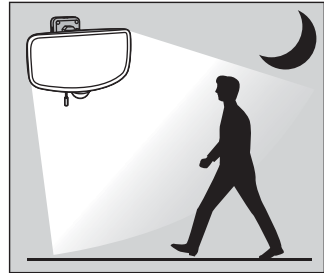
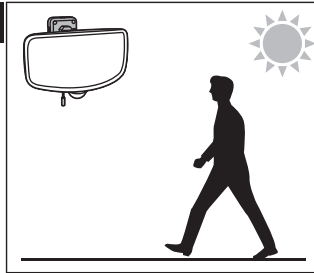

All-night lighting mode

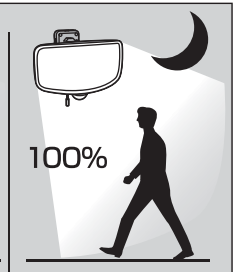
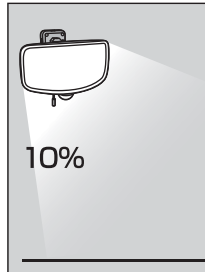
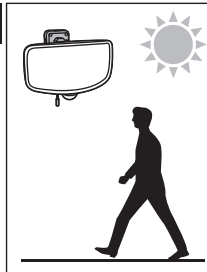

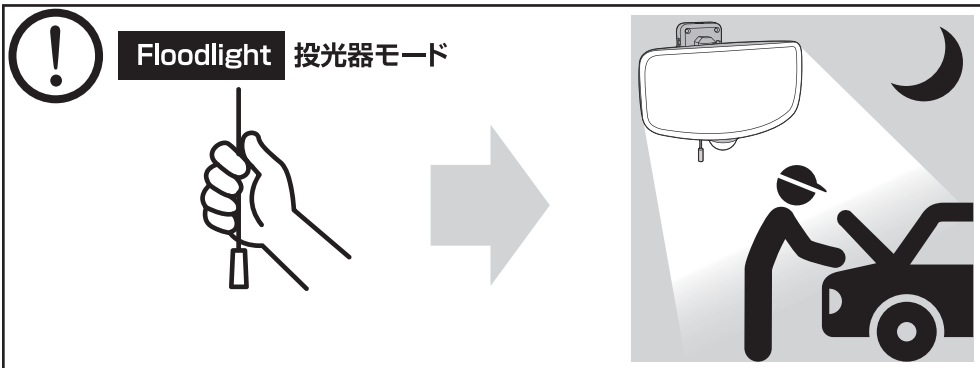

株式会社 ムサシ

〒675-1201 兵庫県加古川市八幡町宗佐1440
Eメール：info@634634.jp
ホームページ：http://www.634634.jp



お客様
相談窓口

0570-033-634

平日 AM9:00 ~ PM5:00

IP電話からは **050-3503-6345**